

Contents

1、 Safety Precautions Symbols	1
2、 Symbols and Definitions	2
3、 Accessories and Spare Parts List	3
4、 Installation	
1)、 Specifications	4
2)、 Duty Cycle and Overheating.....	5
3)、 Machine Installation.....	6
4)、 Selecting a Location.....	7
5)、 Connecting Input Power	8
5、 Operation	
1)、 Controls.....	9
2)、 Welding Gun and Adaptors.....	10
3)、 Various Operations	
a、 Spot Welding	11
b、 Washer Welding	12
c、 Triangle Washer Welding.....	13
d、 Carbon Rod Heating.....	14
e、 Wave Form Wire Welding	15
f、 Cupules	16
6、 Maintenance	
1、 Exploded View	17
2、 Troubleshooting.....	18
7、 Electrical Diagram	19
8、 Packing List	

Safety Precautions Symbols



Protect yourself and others from injury, read and follow these precautions before installation and operation.

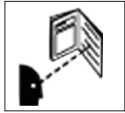

Read instructions.
 1. Read owner's Manual before using or servicing unit.
 2. Use only manufacturer's supplied replacement.



Electric shock can kill:
 1. Do not touch live electrical parts.
 2. Wear dry, hole-free insulating gloves and body protection.
 3. Do not wrap electrical cable around your body.
 4. Ground the workpiece with a good electrical ground.



Exploding parts can injure. Always wear a face shield and long sleeves.



Fumes and gases can be hazardous welding produces fumes and gases. Breathing these fumes and gases can be hazardous to your health.
 If inside, ventilate the area.
 Do not weld in a confined space only if it is well ventilated.



Static can damage PC boards
 1. Put on grounded wrist strap before handling boards or parts.
 2. Use proper static-proof bags and boxes to store, move or ship PC boards.

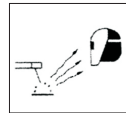

Eye protection for welding:
 Current level in amperage Minimum shade
 Number
 30-150A----- #8
 150-300A----- #10
 300-500A----- #12



1. Wear approved face shield or safety goggles with side shields.
 2. Wear proper body protection to protect skin.



The heat from the workpiece can cause serious burns.

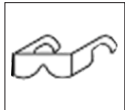

Flying metal can injure eyes.
 1)Wear safety glasses with side shields or face shield.



Remove all flammables of the welding area.



1. Magnetic fields can affect pacemakers. Pacemaker wearers keep away.
 2. Wearers should consult their doctor before going near plasma arc cutting operations.



Falling unit can cause injury.



Overuse can cause overheating
 Allow cooling period , follow rated duty cycle before starting to weld again.



Fire or explosion hazard.
 Do not locate unit on, over, or near combustible surfaces. Do not install unit near flammables.



Do not weld in the height!



Never cut on pressurized cylinder.



Protect yourself



Warn others



OK



OK



















Factory safety!



Maintenance regularly!

























Definitions

Symbols and Definitions

A Amperes	I_{1max} Rated maximum supply current	I On	% Percent
V Volts	I_{1eff} Maximum effective supply current	O Off	 Increase
I₂ Rated welding current	IP Degree of protection	 Protective earth (Ground)	 Line connection
S₁ Power rating, product of voltage and current (KVA)	 Single phase	 Do not do this	 Loose shield cup
HZ Hertz	X Duty cycle	 Suitable for some hazardous locations	 Adjust air/gas pressure
U₁ Primary voltage	 Direct current	 Input	 Automatic
U₀ Rated no load voltage (Average)	 Constant current	 Voltage input	 Manual
U₂ Conventional load voltage	 Temperature	 Low air pressure light	

Accessories And Spare parts

Accessories and Spare Parts List:

	Pneumatic vacuum cupule		Pull hammer		Vertical spot welding pull hammer
	Claw puller		Hook		Wriggle
	Carbon Cod		Spot welding electrode tip		Carbon rod adaptor
	Waveform electrode tip		Washer adaptor		Electrode holder
	Trianger washer adaptor		Front part of puller		Triangle wasler
	Stud		Washer		Ground wire clamp
	Manual cupule		Welding gun		Front wheel
	Back wheel		Circuit board		
	Control transformer				

Remark:

- 1)、Optional orders for above accessories and components are available.
- 2)、Model and parts number required when ordering parts from your local distributor.

Installation

1、specifications

Input voltage	220V/380V 50/60HZ
Output voltage	AC1V-13V Kriptol heating AC6V-10V washer welding AC1V-12V double-side welding AC1V-13V
Input power	22KW
Instant max. current	5800A
Input current	57A
Operation way	Electronic timer, continuity
Time regulation system	0-99ms
Operation place	Infinity
One side welding thickness	1.0+1.2 (mm)
Vacuum cupule device	180kg
Dimension	720*600*1550 (mm)
Weight	86kg

2、 Duty Cycle and Overheating

Duty cycle is percentage of 10 minutes that unit can weld at rated load without overheating.

The welder is equipped with over-heat protection. On exceeding the critical temperature, the welder will be stopped automatically. The welder can be used again after cooling down.

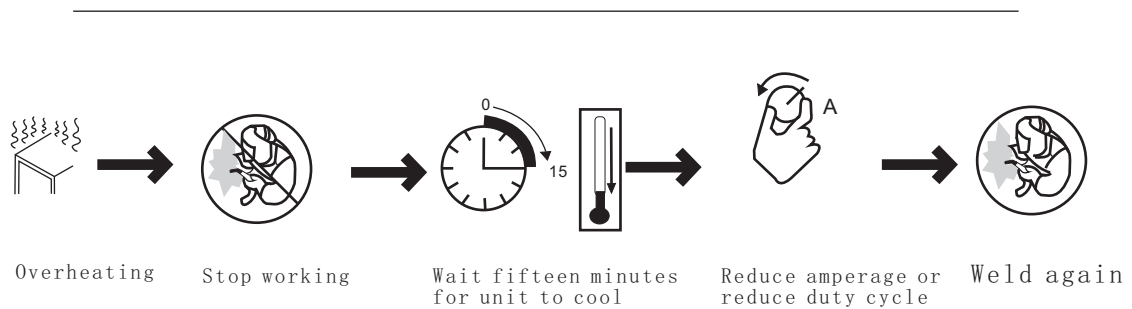

3、 Machine Installation

- 1) Open the package and find out the owner's manual.
- 2) Check the supplied of accessories according to packing list that attached to this manual.
- 3) Properly install this equipment as following diagram. Inspect the unit for any problems. If so, contact your local distributor or service agency. To locate a distributor or service agency.

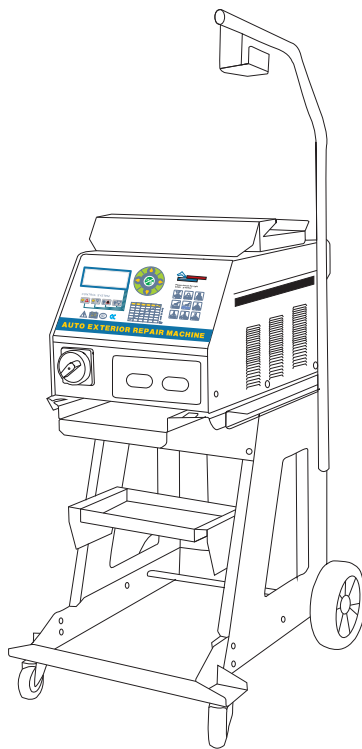

4、 Selecting a Location

- 1) Select a correct location to place the unit.
- 2) Determine input power cord length according to its actual operation requirement .Make sure that the supply cable is at least 6mm² in diameter
- 3) Do not move or operate unit where it could tip.
- 4) Use cart or unit handle to move unit .Do not pull the cords to move unit.

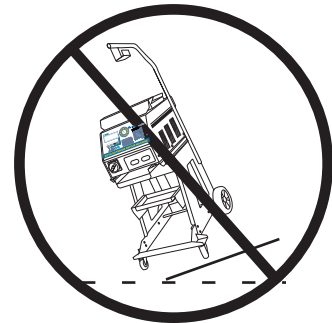
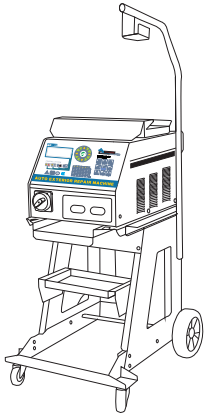

5、Connecting Input Power

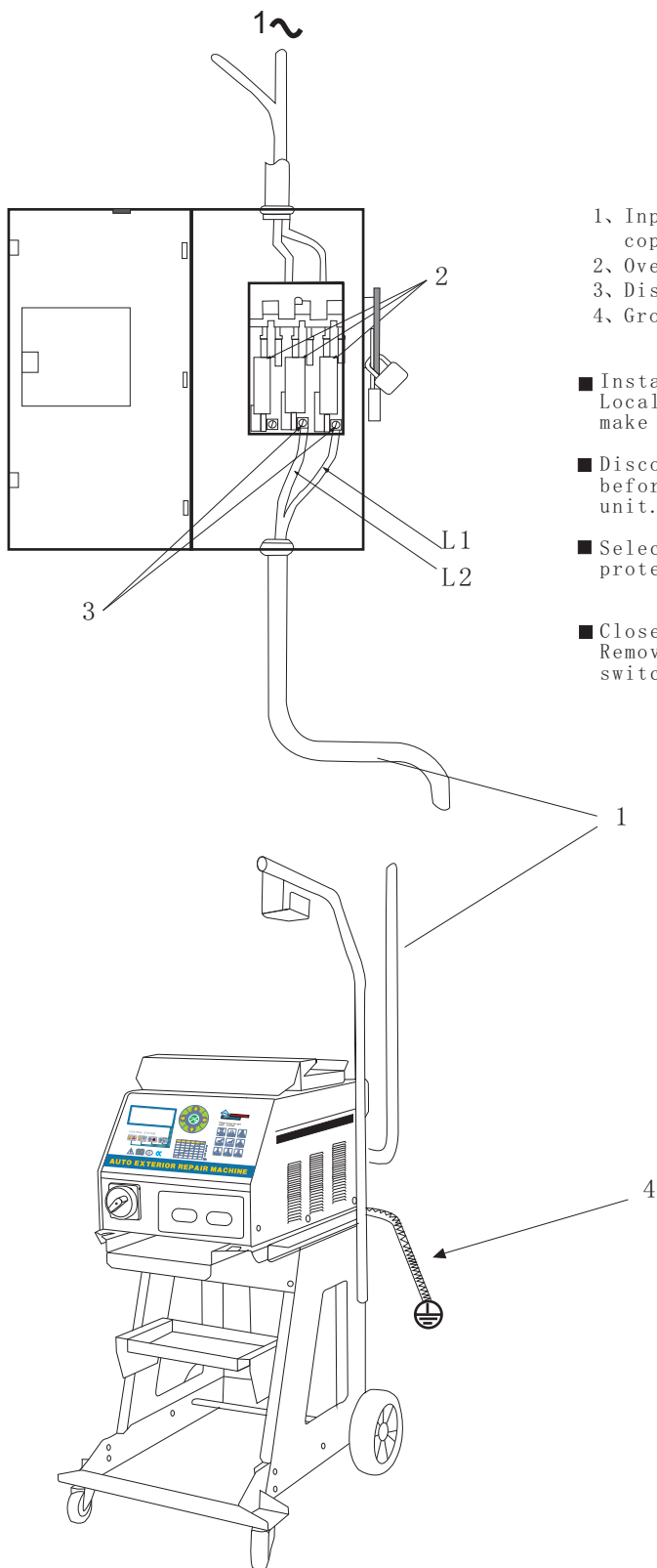

- 1、Input power cord (not less than 6mm² copper cord) .
- 2、Over-current protection.
- 3、Disconnect device line terminals.
- 4、Ground wire L1/L2 input conductors.

- Installation must meet all National and Local Codes---have only qualified persons make this installation.
- Disconnect and lockout/tagout input power before connecting input conductors from unit.
- Select type and size of over-current protection.
- Close and secure door on disconnect device . Remove lockout/tagout device, and place switch in the "on" position.

Operation

1、Controls

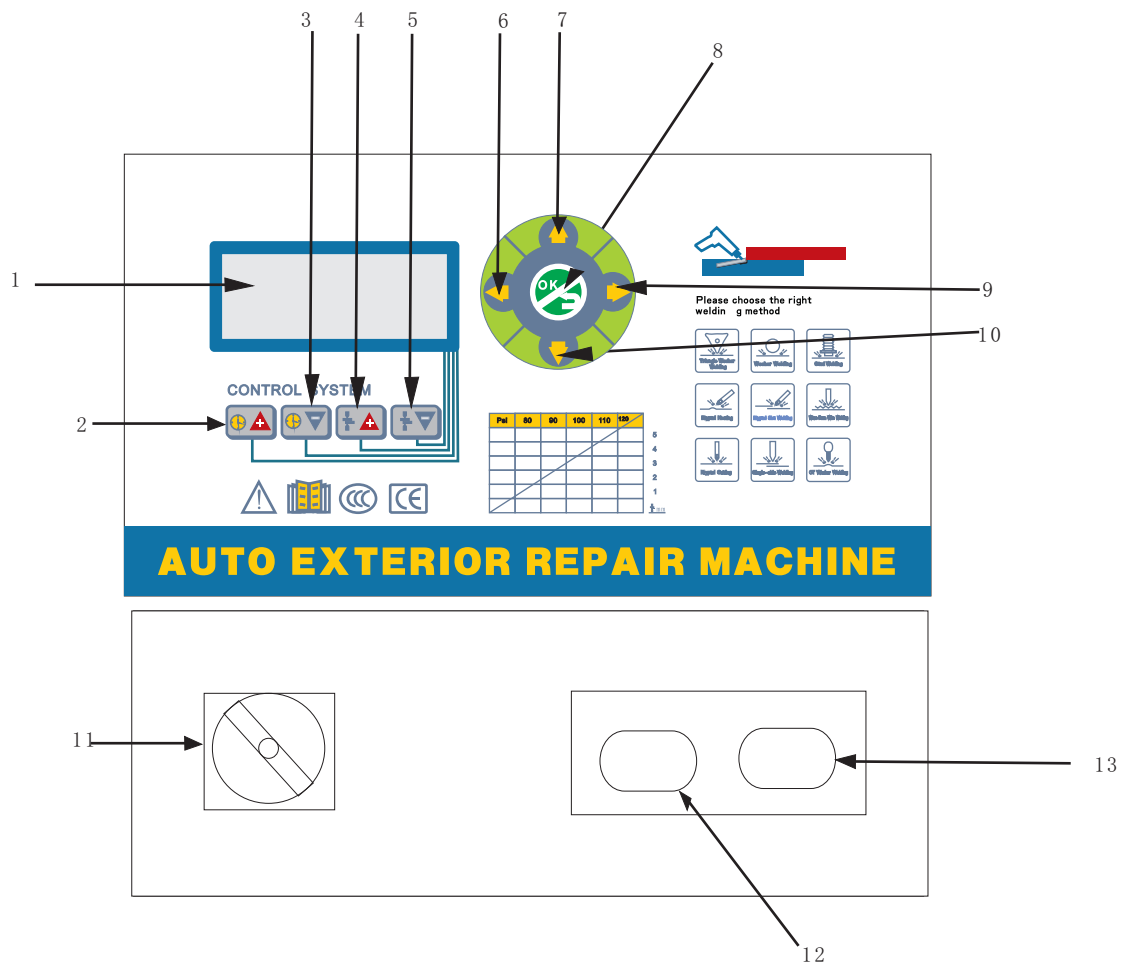

- 1、LCD Display
- 2、Time adjustment (Increase)
- 3、Time adjustment (Decrease)
- 4、Current adjustment (Increase)
- 5、Current adjustment (Decrease)
- 6、Left
- 7、Up
- 8、Enter/return
- 9、Right
- 10、Down
- 11、Power switch
- 12、Negative outside wire
- 13、Welding gun Output Cable

2. Welding Gun and Adaptors

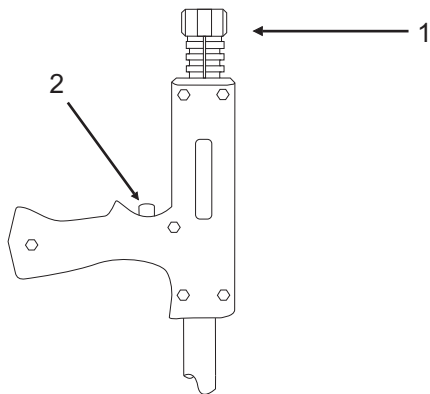

- 1, Electrode holder
- 2, Trigger

Single-Sided applications

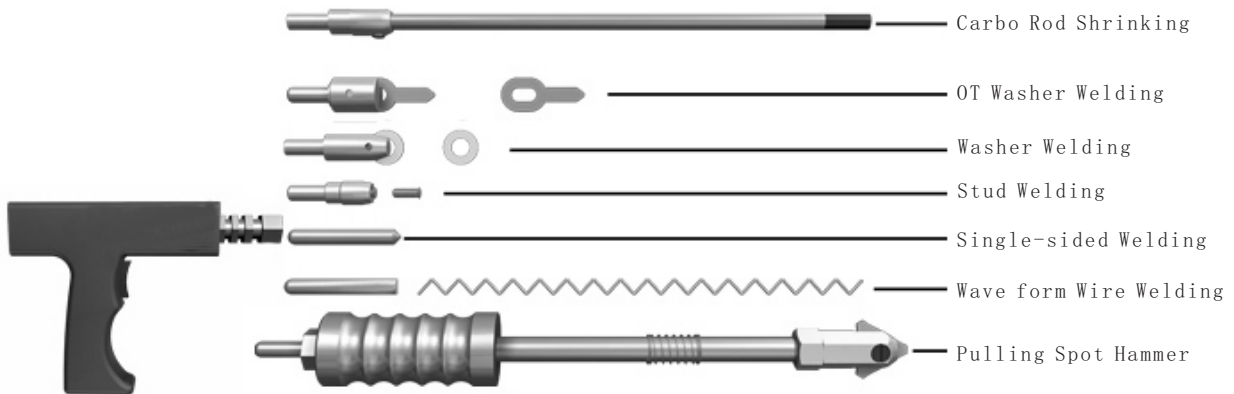

Connection of negative wire

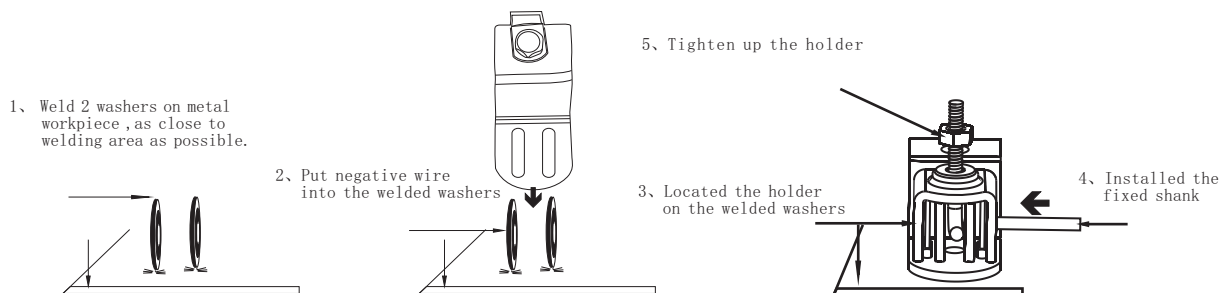

3、Operation

a、spot welding

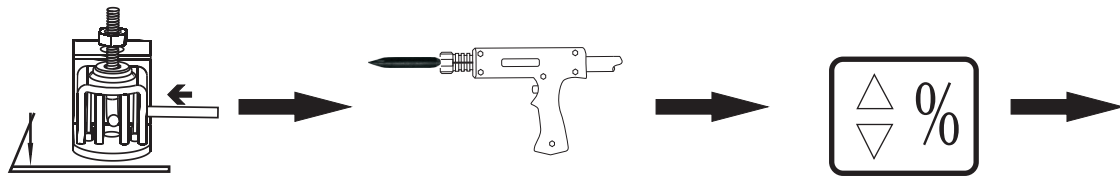

Connect negative outside wire to a clean, paint-free location on metal workpiece, as close to welding area as possible.

Connect spot welding electrode tip with welding gun and tighten.

Set correct amperage.

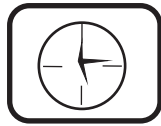

Set correct time.

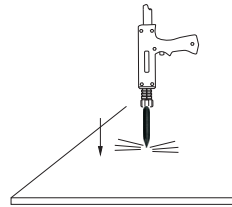

Approximately a 90° angle to the workpiece surface.
Put on pressure and press trigger.

Remark:

- 1、Setting amperage too high or time too long can cause workpiece surface (vehicle body) damage .
Please weld other workpieces for practice before actual operations.
- 2、Setting correct amperage and time according to the workpiece thickness.
- 3、Continuing another operation is available after this procedure finished . If not, please shut off the main power supply and switch off the unit.

3、Operation

b、Washer Welding

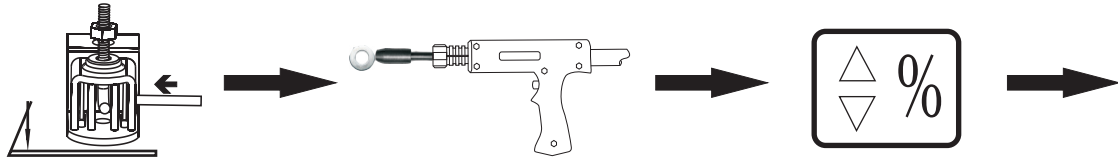

Connect negative outside wire to a clean, paint-free location on metal workpiece, as close to welding area as possible.

Connect washer adaptor with welding gun and tighten, Install washer.

Set correct amperage.

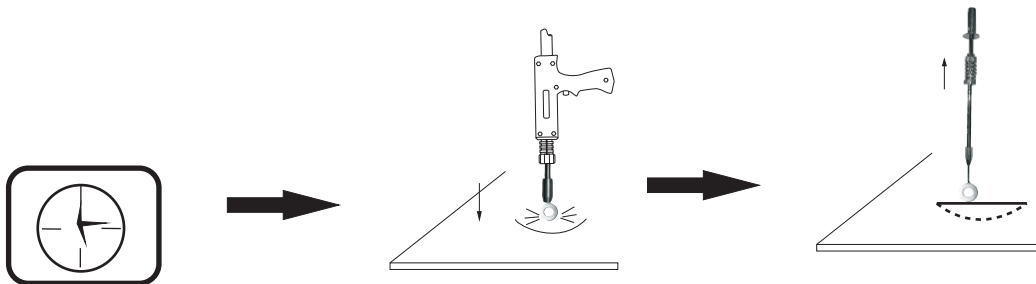

Set correct time.

Approximately a 90° angle to the dent. Put on pressure and press trigger.

Remove welding gun. Hook the washer with pull hammer. Slide the hammer to opposite direction to pull out the dent .

Remark:

- 1、Setting amperage too high or time too long can cause workpiece surface (vehicle body) damage . Please weld other workpieces for practice before actual operations.
- 2、Setting correct amperage and time according to the workpiece thickness.
- 3、Continuing another operation is available after this procedure finished . if not, please shut off the main power supply and switch off the unit.

3、Operation

c、Triangle Washer Welding

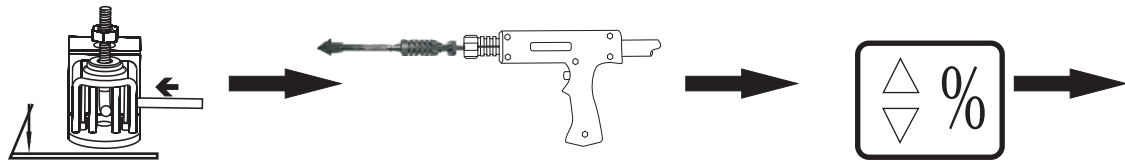

Connect negative outside wire to a clean, paint-free location on metal workpiece, as close to welding area as possible.

Connect triangle washer pull hammer with welding gun.

Set correct amperage.

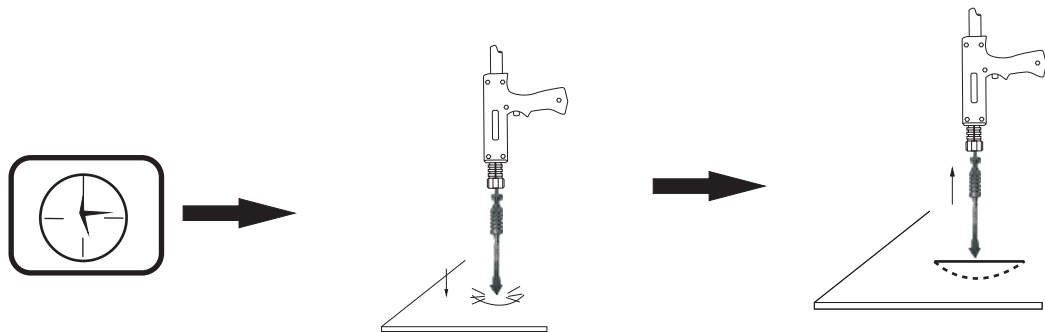

Set correct time.

Approximately a 90° angle to the dent, put on pressure and press trigger.

Slide the hammer to opposite direction to pull the dent out.

Remark:

- 1、Setting amperage too high or time too long can cause workpiece surface (vehicle body) damage . Please weld other workpieces for practice before actual operations.
- 2、Setting correct amperage and time according to the workpiece thickness
- 3、Triangle washer welding can replace washer welding. It can pull out the dent directly after welded.
- 4、Continuing another operation is available after this procedure finished .If not, please shut off the main power supply and switch off the unit.

3、Operation

d、Carbon rod Heating

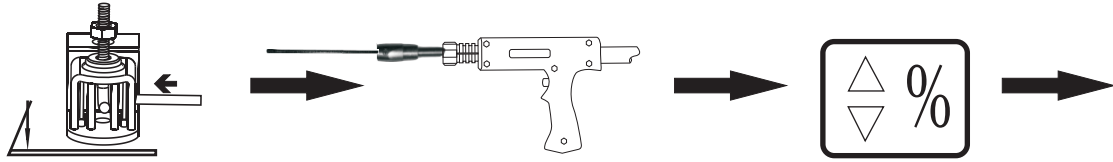

Connect negative outside wire to a clean, paint-free location on metal workpiece, as close to welding area as possible.

Connect carbon rod and carbon rod adaptor with welding gun.

Set correct amperage.

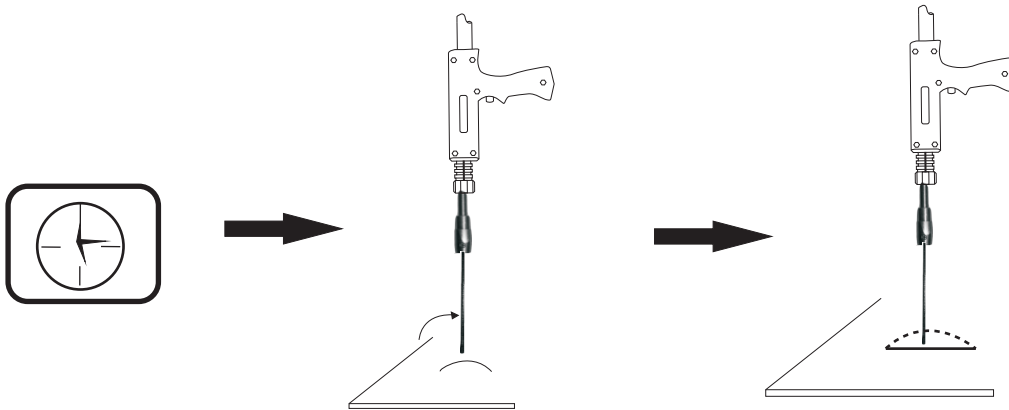

Set correct time.

Carbon rod turning in clockwise to heat up the stretched panel

Use cold water or wet rag to cool down the heated area that makes the stretched panel shrunken as normal status.

Remark:

- 1、Setting amperage too high or time too long can cause workpiece surface (vehicle body) damage . Please weld other workpieces for practice before actual operations.
- 2、Setting correct amperage and time according to the workpiece thickness.
- 3、Continuing another operation is available after this procedure finished . If not, please shut off the main power supply and switch off the unit..

3、Operation

e、Wriggle Form Wire Welding

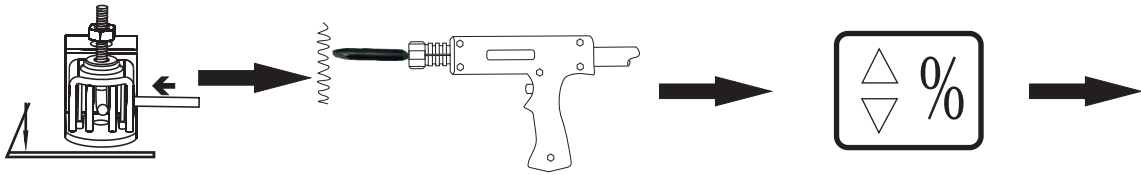

Connect negative outside wire to a clean, paint-free location on metal workpiece, as close to welding area as possible.

Connect wriggle wire electrode tip with welding gun.

Set correct amperage.

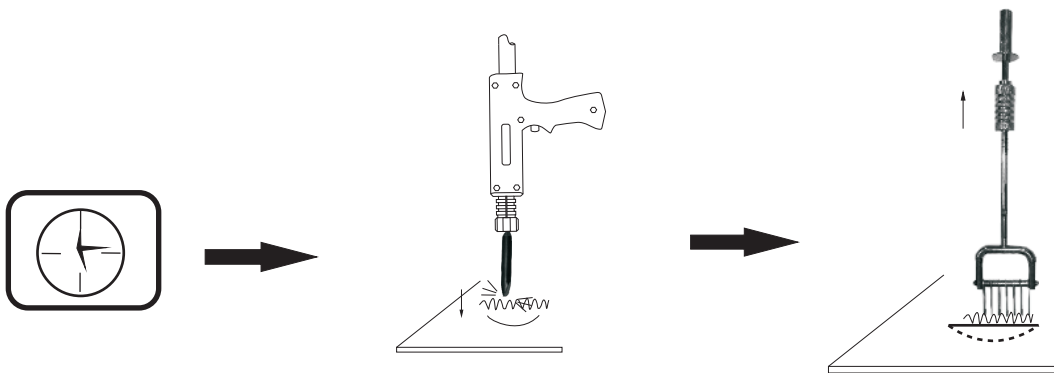

Set correct time.

Place a wave form wire horizontally on the dent. Approximately a 90° angle to wave form wire. Put on pressure and press trigger.

Connect hook puller with pull hammer. Hook wave form wire and slide the hammer to pull out the dent.

Remark:

- 1、Setting amperage too high or time too long can cause workpiece surface (vehicle body) damage . Please weld other workpieces for practice before actual operations.
- 2、Setting correct amperage and time according to the workpiece thickness.
- 3、Continuing another operation is available after this procedure finished . If not ,please shut off the main power supply and switch off the unit.

3, Operation

f, Cupules

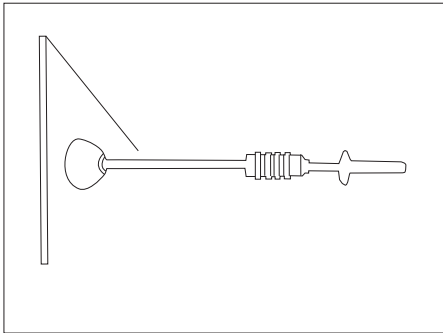

Manual operating cupule:

- 1, Connect manual cupule with pull hammer.
- 2, Push manual cupule in to lock the cupule on the dent.
- 3, Slide the hammer to opposite direction to pull the dent out.

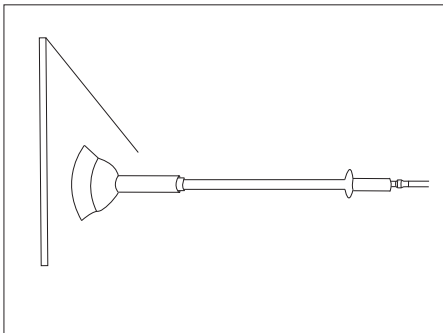

Pneumatic vacuum cupule:

- 1, Connect gas/air supply with the adaptor of cupule.
- 2, Open the valve , sticking cupule to the dent.
- 3, Slide the hammer to opposite direction pull the dent out.
- 4, Cupule falls off when close the valve.

Maintenance

1、Exploded view

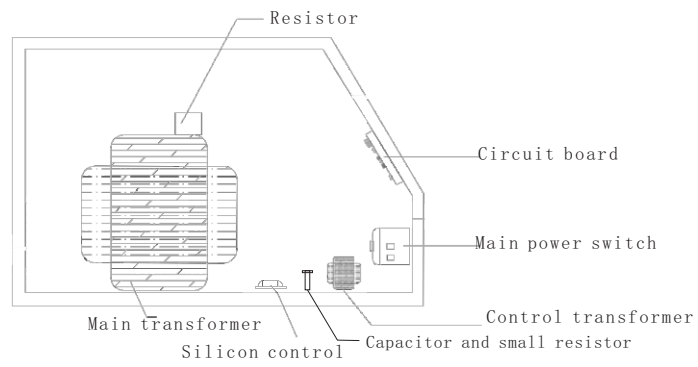

Left side view

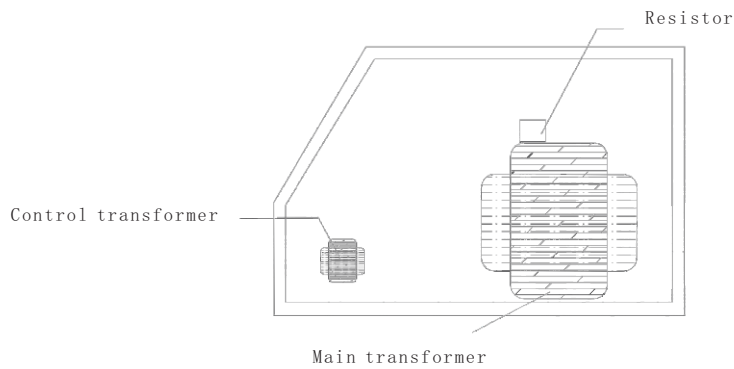

Right side view

Maintenance

2、Troubleshooting

Trouble	Reason	Remedy
No welding output	(1) Connected power supply incorrectly. (2) Power switch in off position	(1) Connect power supply according to manufacturer's instructions. (2) Place power switch in "on" position.
Trigger not working	(1) Trigger damaged. (2) Gun control wire broken. (3) Control wire plug loosen. (4) Mode switch in incorrect position.	(1) Replace trigger. (2) Connect again or replace if necessary. (3) Connect control wire plug again. (4) Place Mode switch in correct position.
Poor weld	(1) Amperage too low . (2) Weld time too short. (3) Input power cord did not meet the requirement. (4) Ground clamp bad contact.	(1) Increase amperage setting. (2) Increase time setting. (3) Replace input power cord. (4) Change ground clamp location.
Piercing workpiece	(1) output amperage too high. (2) Weld time too long. (3) Bad contact of electrode tip or washer with workpiece.	(1) Reduce amperage setting. (2) Reduce weld time. (3) Remove coating from material reduce added pressure.
Carbon rod working unstable	(1) Carbon rod or workpiece is dirty (2) Incorrect amperage and time setting.	(1) Polish carbon rod and workpieces (2) Set amperage and time according to workpiece thickness.
Unit stop working while operation	(1) Trigger plug loosen. (2) Gun control wire broken. (3) Over heating.	(1) Check gun control wire and trigger plug. (2) Wait for temperature cool down.

Circuit Diagram

